

# Comparison of PMAT Camera Holder with Human Camera Holder

<sup>1</sup>RK Mishra, <sup>2</sup>D Lorias, <sup>3</sup>A Minor

<sup>1</sup>Director and Laparoscopic Surgeon, Laparoscopy Hospital, New Delhi, India

<sup>2</sup>CINVESTAV IPN Electrical Department, Mexico DF

<sup>3</sup>CINVESTAV IPN Electrical Department, Mexico DF

## Abstract

*Aim:* During minimal access surgery an assistant is controlling the laparoscope and surgeon should be free to manipulate instruments. Although the advantages of laparoscopic surgery are well documented, one disadvantage is that, for optimum performance, an experienced camera driver is required who can provide the necessary views for the operating surgeon. There are many drawbacks in human camera operator especially if they are not trained. The self camera-control by the surgeon gives more stability of the laparoscopic image. The aim of this study was to compare PMAT camera holder device with traditional assistant-driven laparoscopic camera control.

*Materials and Methods:* Laparoscopic Appendicectomy, Ovarian Cystectomy and Laparoscopic sterilization were performed. On 14 patients, the operating surgeon used the "PMAT" and performed the surgery without a laparoscopic camera assistant. On the other group of 14 patients, an experienced camera operator was responsible for control of the laparoscopic field of vision in the traditional manner. The time required for surgery was documented.

*Results:* The mean operative times for PMAT and camera person-assisted appendicectomy was 45 minutes and 40 minutes respectively. For ovarian cystectomy 45 and 50 minutes and for laparoscopic sterilization it was 15 and 10 minutes. There were no differences in outcome of surgery or blood loss in the two groups. The operative surgeon perceived some increase in shoulder and neck pain with use of the PMAT scope holder.

*Conclusions:* This PMAT device provides a means for the operative surgeon to safely perform simple laparoscopic procedures alone without significantly increasing operative time or morbidity.

**Keywords:** Laparoscopic surgery, Robotic Surgery, Device Camera, EndoAssist, Camera holder.

## INTRODUCTION

In the current era of evidence based medicine enthusiasm for laparoscopic surgery is rapidly gaining momentum. There is an immense amount of literature showing advantages of minimal access surgery and acceptance by almost all the surgical speciality.<sup>1,2</sup> The advantages of laparoscopic surgery are well documented but there are significant challenges not only to the operating surgeon but also to the person who holds laparoscope.

In laparoscopic surgery, the operating surgeon does not have direct visual control of the operative field. The surgeon depends on the camera assistant to maneuver the camera for optimum visualization of laparoscopic target of dissection.<sup>3-6</sup> In only advanced units and hospital the laparoscopic team can afford to use an experienced camera assistant, elsewhere this is not economically feasible on a regular basis. This difficulty and helplessness of surgeon is compounded by the fact that cooperation must occur on a real-time basis with each step and camera person should be adequately trained in laparoscopy. As such, independent driver bias arises where conflicts of cooperation and skill can occur in which the surgeon's optimum view is somewhat hampered by the camera driver's perception. Manual camera control can also be physically demanding leading to fatigue and a suboptimum visual field when the camera operator is exhausted. During prolonged procedures frustration and conflicts can occur between camera operator and surgeon. Very often an equally experienced camera driver is required as the surgeon to facilitate necessary views for the operating laparoscopic surgeon. Ideally, the surgeon should have full control of all instruments required that are directly required for conducting a given minimal access surgical procedure. This includes surgical operative instruments and control of the operative field. The purpose of non-human motorized camera holders is to facilitate camera-control to the surgeon and to stabilize the visual field during minimally invasive procedures. Recently many such, active and passive camera holders have been developed everywhere in the world to offer the surgeon an alternative and better tool for control of the operating surgeon.<sup>7,8</sup> The advantages of non-human camera operator include:

- Elimination of the fatigue of the assistant who holds the camera.
- Elimination of fine motor tremor and small inaccurate movements.
- Delivery of a steady and tremor-free image.
- Non-dependency on camera operator.
- Reduced cost of surgery.
- Reduced number of highly skilled staff.

In this study, we describe our experience with laparoscopic techniques using a PMAT camera holder.

### Materials and Methods

To manipulate the laparoscope along with the visual perception, this mechatronic assistant with three degrees of freedom was used (Fig. 1). This mechatronic device is made of aluminum and weighs 2.5 kg, including laparoscope and camera. This system consists of a harness (Fig. 2A) that is placed over the surgeon's shoulders.

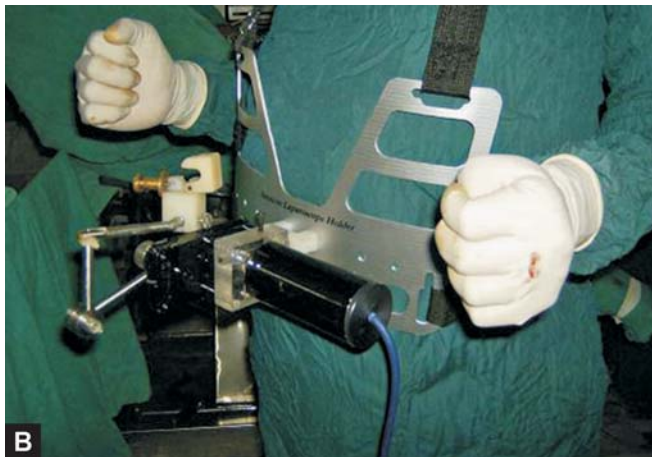
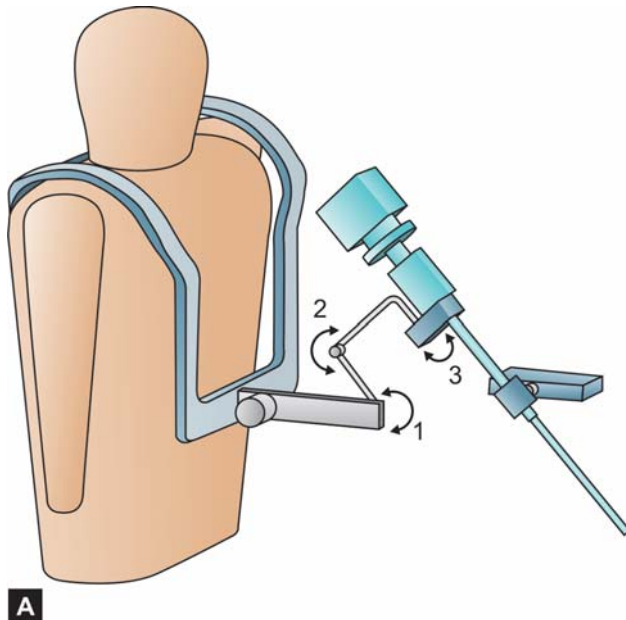

**Fig. 1:** PMAT laparoscopic camera holder (A) design, (B) current prototype.

The first degree of freedom is subject to the harness and is the active part (Figure 2B), while the other two degrees are the passive ones (Figure 2C). The end of the whole part is attached both to the laparoscope and to the camera, with a device called

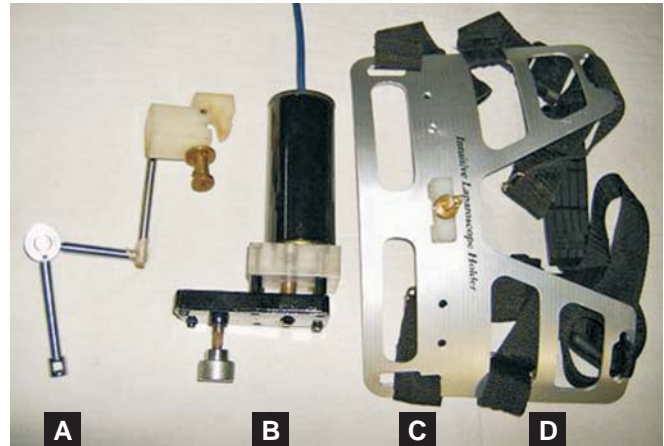

**Figs 2A to D:** PMAT and parts: (A) harness, (B) active link, (C) passive link, (D) laparoscope holder.

laparoscope holder (Figure 2D); this can be easily removed manually. To make movements inside the patient this mechatronic system uses a supporting point and movement to the port of entry from the laparoscope to the patient. To navigate the laparoscope, we need six basic movements: Up, down, in, out, to the left, to the right. To perform any of these movements inside the space along with the harness, the surgeon will use the following techniques: For the right and left movements of the laparoscope, it is advisable to use lateral body movements along with the last passive link of the system (Fig. 3A). A more valuable movement can be achieved through a partial change in the lateral posture of the surgeon's torso. There are two ways to insert or to remove the laparoscope: Either the surgeon moves his/her torso close to or away from the patient, or he/she uses his/her entire body to perform these movements (Fig. 3B). The angle of entry or exit of the laparoscope for the up and down positions inside the patient is obtained with the assistance of the active rotative link and the second passive link along with the near and far position of the surgeon's body to the point of insertion as illustrated in Fig. 3C. The active degree of freedom is moved in both ways using two switches. To make mixed movements, the surgeon moves his/her body through visual perception.

The mechatronic assistant was developed at CINVESTAV IPN. In electrical department. Mexico Patent number 1540. It was Simulated in Visual Nastran software and tested in box trainer with phantom model and animal model before clinical trial over human.<sup>9</sup> Practical application the study included a total of 28 laparoscopic procedures in which 14 were performed without PMAT and 14 with PMAT. The procedures were conducted by three experienced surgeons and gynecologists and included, 12 Appendectomy, 8 ovarian cystectomy, and 8 laparoscopic sterilization. Before using PMAT its lever was dipped into Cidex overnight. The wearing plate and electrical part of PMAT was kept in formalin chamber overnight to facilitate proper disincentive action. The PMAT was applied to the neck

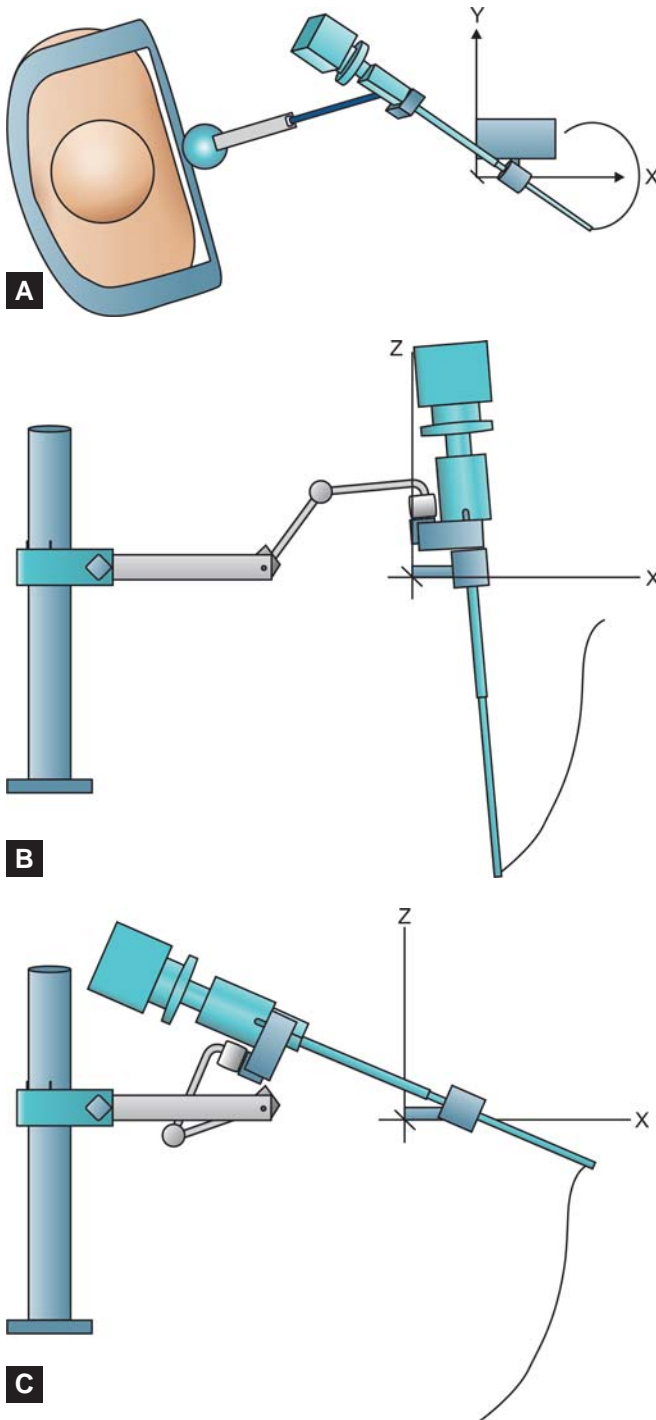

**Figs 3A to C:** Movements: (A) right and left, (B) in and out, (C) up and down.

of the surgeon once the access is complete. Veress needle technique was used for access in this study. All non-complicated simple cases were selected for this study. Human camera operator was kept in standby throughout the procedure during this study so that in case of difficulty he can takeover of camera.

The surgeon noted:

1. The extent of body comfort and muscle fatigue, by using a modified body part discomfort
2. Ease of scope movement or usability
3. Need to clean the telescope
4. Time of set-up the PMAT
5. Overall operative time
6. Surgical performance, and
7. Necessity to change the position and side of the table during surgery

During all the procedure a thirty-degree Storz laparoscope was used. Camera of Maxer (Germany), and the Telescope (Hanki sass Wolf) were used in surgery.

### Results

All cases included in this study were free from any intraoperative complications including major bleeding or other factors which would have demanded additional hemostatic or reconstructive steps. With regard to the extent of body comfort and muscle fatigue, all three surgeons involved with the evaluation felt comfortable with the PMAT for each of the laparoscopic procedures studied, with no loss of autonomy. The surgeons were slightly felt fatigue with use of the PMAT for laparoscopic procedure which took more time, and prompting for motion adjustment was required repeatedly for the cases studied. With regard to ease of scope movement and the need to clean the telescope, we found that, on average, the PMAT need more time to disconnect the telescope. The time of set up was also analyzed and overall set up time was more for PMAT than human camera operator. The set-up time for all cases was under 5 min (graphic 1). With regard to surgical performance, all three surgeons reported that the PMAT device did not compromise surgical performance if co-axial alignment was maintained (Eye of the surgeon, target of dissection and centre of the monitor in same line). They also reported that the PMAT device was a viable option which enabled optimum task performance for all the types of case studied, and comparable with use of a human camera driver. There were no significant differences between complication rates or total operative time for procedures conducted with the PMAT device or with a conventional human assistant (Table 1), (Graphic 2). With regard to the need to clean the scope, we found this was not a useful tool for measuring the performance of the PMAT because it varies from case to case. Scope cleaning depends on several factors, e.g. the assistant driving the camera, the body fat of the patient, the type of surgery being performed, temperature difference with telescope and patient anatomy.

### Discussion

Kavoussi et al<sup>10</sup>, in 1995 reported results of a study on the accuracy and use of a robotic surgical arm compared with a

**TABLE 1: Time using the human camera driver and PMAT**

Operative Time						
Laparoscopic Appendicectomy			Laparoscopic Ovarian Cystectomy		Laparoscopic Sterilization	
<i>n</i>	Human Assistant	PMAT	Human Assistant	PMAT	Human Assistant	PMAT
1	39	40	42	54	14	9
2	43	47	49	47	17	10
3	39	49	44	49	15	9
4	38	45	45	50	14	12
5	42	44	—	—	—	—
6	39	45	—	—	—	—
<b>Σ/n</b>	<b>40</b>	<b>45</b>	<b>45</b>	<b>50</b>	<b>15</b>	<b>10</b>

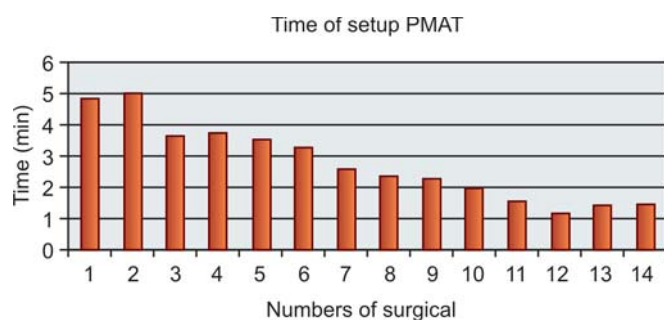

**Graphic 1:** Time of setup the PMAT operative time

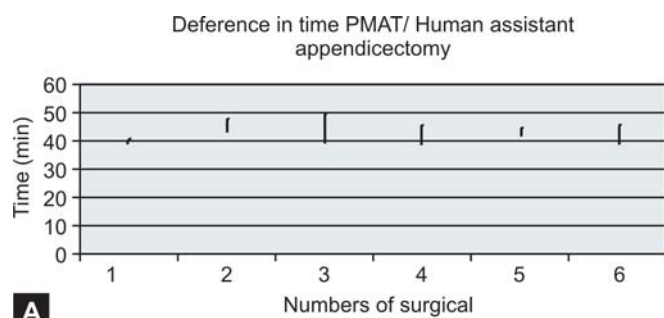
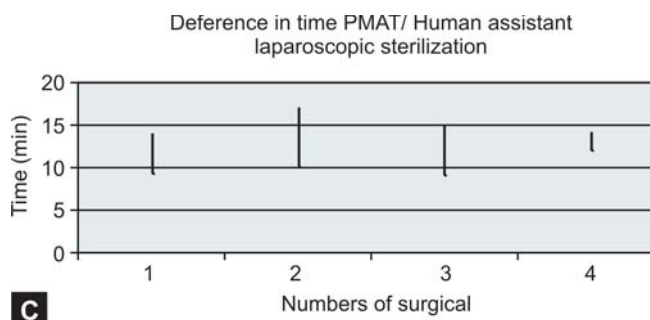

**A**

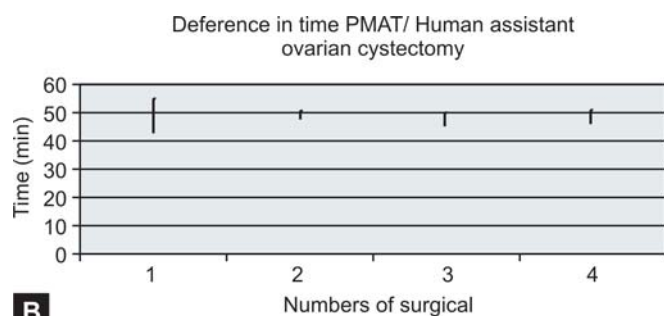

**B**

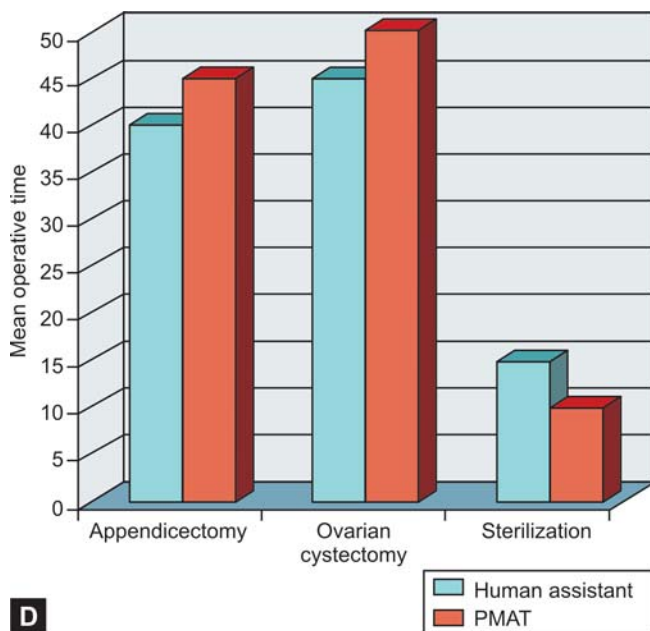

**D**

**Graphic 2:** Difference in time using PMAT and human assistant: (A) Laparoscopic Appendicectomy, (B) Laparoscopic Ovarian Cystectomy, (C) Laparoscopic Sterilization, (D) Mean operative time during the surgical procedures

human surgical assistant during urological laparoscopic surgery. They observed that camera positioning was significantly steadier with fewer inadvertent movements when under robotic rather than human control. They found no significant difference in the operative times during dissections using the robot or human assistant, however. Begin et al,<sup>11</sup> defined the motions of the human camera operator and expressed them mathematically by use of a spherical displacement model. They then applied this to a revolving robotic arm with six degrees of freedom in conjunction an automated camera in the performance of cholecystectomy and other procedures in animal models. Turner compared the cost-effectiveness of using a robotic assistant instead of a human assistant in a series of 12 cases of solo surgery in laparoscopic bladder neck suspension. He concluded that the cost of the robotic arm was less than that of human systems and that the former was a cost-effective means of performing the procedure.<sup>11</sup> Having discovered that non-human-controlled camera devices were economically and technically feasible, several groups sought to compare the different devices. Robotic arm outperformed human camera holders and improved efficiency and cost savings. The current price of the AESOP (Robotic camera operator is \$100,000 US dollars). It is not possible for every surgeon to use robotic camera operator due to the cost. Keeping in mind all these constrain to manipulate the laparoscope along with the visual perception, we propose a mechatronic assistant with three degrees of freedom. This mechatronic device is made of aluminum and weighs only 2.5 kg, including laparoscope and camera. It would be very cost effective and performance-wise similar to that of an AESOP device. These costs when balanced against use of man power and cost per hour of employing a human camera driver points in favor of the non-human-controlled camera devices from a strictly health economics point of view. One of the big advantage with PMAT is complete autonomy of the surgeon to obtain the desired optimum operator view without relying on the experience and skill of his assistant. The disadvantages of the PMAT are that it cannot be used where surgeons want to operate in wide area and in the cases where co-axial alignment cannot be maintained during whole procedure. It is good for fixed and small target of dissection, where camera can be fixed between the working instrument and where the co-axial alignment can be maintained throughout the procedure. Use of the finger-operated electronic switch sometimes results in the need to take surgeons eye off the operative field to search for the switch which will move camera in or out. It is also necessary for the surgeon to learn to use the PMAT, but proficiency in the execution of the camera movements is easily acquired in a few minutes. There was slight neck or shoulder discomfort. Even after these minor problems in our study the PMAT enabled the surgeon to intuitively control his field of laparoscopic vision without compromising

the movements of his instrumentation during laparoscopic surgery.

## CONCLUSION

The PMAT is an intuitive, effective and easy to use device for holding camera during simple laparoscopic procedures like laparoscopic appendicectomy, ovarian cystectomy and sterilization. It can replace the human camera operator where surgeon can himself maintain co-axial alignment. PMAT reduces the constraint of requiring an experienced camera driver for optimum visualization during laparoscopic procedures. Further large scale feasibility studies to accept it as a useful tool for every surgeon are warranted.

## REFERENCES

1. Novitsky YW, Litwin DEM, Callery MP. The net immunologic advantage of laparoscopic surgery *Surgical Endoscopy* Volume 18, Number 10 / October, 2004.
2. Stocchi L, Nelson H, Young-Fadok T M, Larson DR, Ilstrup D M. Safety and advantages of laparoscopies open colectomy in the elderly. *Diseases of the Colon & Rectum* 2003;43; 3.
3. Jaspers, Joris E. Breedveld N, Paul, Herder, Just L, Grimbergen, Cornelis A. Camera and Instrument Holders and Their Clinical Value in Minimally Invasive Surgery. *Surgical Laparoscopy, Endoscopy & Percutaneous Techniques*. 2004;14(3):145-152.
4. Sejal S Quayle, Collyer W, Vanlangendonck R, Jaime Landman. Comparison of a Novel Endoscope Holder and Traditional Camera Assistant for Laparoscopy Simple. Nephrectomy in a Porcine Model. *Journal of Endourology*, 19, 2005;2:218 -20.
5. Proske JM, Dagher I, Franco D. Comparative study of human and robotic camera control in laparoscopic biliary and colon surgery. *Journal of Laparoendoscopic & Advanced Surgical Techniques-part A* 2004;14(6):345-48.
6. Buess GF, Arezzo A, Schurr MO, Ulmer F, H de Pescador, Gumb L, Testa T, Nobman C. A new remote-controlled endoscope positioning system for endoscopic solo surgery. *The FIPS endoarm*. *Surg Endosc* 2000;14(4):395-99.
7. Aiono S, Gilbert JM, Soim B, Finlay PA, Gordan A. Controlled trial of the introduction of a robotic camera assistant (EndoAssist) for laparoscopic cholecystectomy, *Surg Endosc* 2002;16(9): 1267-70.
8. Nebot PB, Jain Y, Haylett K, Stone R, McCloy R. Comparison of Task Performance of the Camera-Holder Robots EndoAssist and Aesop *Surgical Laparoscopy, Endoscopy & Percutaneous Techniques* 2003;13(5):334-38.
9. Minor R. Muñoz J. Nieto R. Ondorica. Postural Mechatronic Assistant for Laparoscopic Training , *Minimally Invasive therapy* 2005;14(6):357-59.
10. Kavoussi LR, Moore RG, Adams JB, Partin AW. Comparison of robotic versus human laparoscopic camera control. *J Urol* 154(6):2134–2136. Erratum in: *J Urol* 1997 158(4):1530;1995.
11. Begin E, Gagner M, Hurteau R, de Santis S, Pomp A. A robotic camera for laparoscopic surgery: conception and experimental results. *Surg Laparosc Endosc* 5(1):6–11 12; 1995. Turner DJ (1996) Solo.